

kpl. Satz NS0ES90

NS0ES90H

NS0ES90HD
NS0ES90HDV

CS0ES90T

NS0ES90DR

ohne Taste
no push button

H-Taste
H- push button

HD- oder HDV-Taste
HD- or HDV- push button
waterproof

Totmann
deadman

Drehtaster
twist knob

mechanische Verriegelung
mech. interlock

ohne Taste
without push button

mit HD- oder HDV-Taste
with HD- or HDV- push button

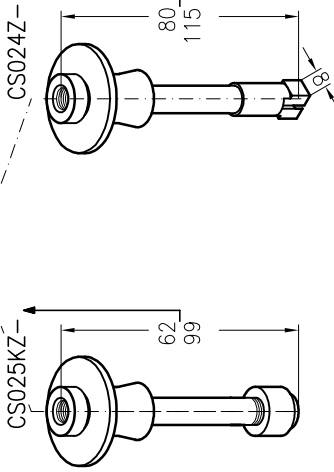
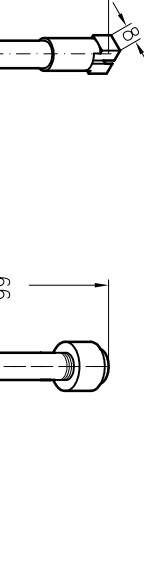
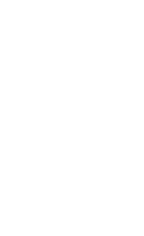
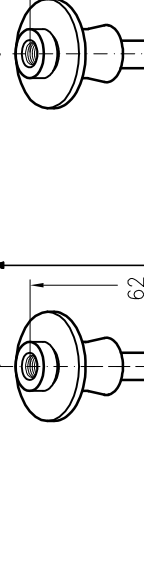
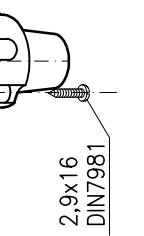
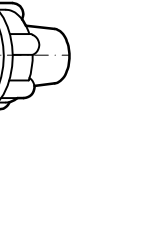
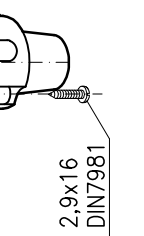
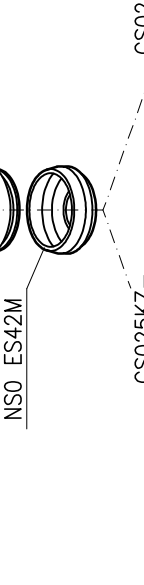
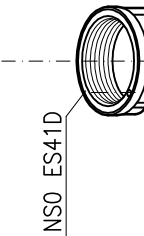
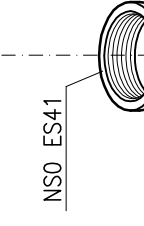
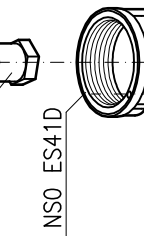
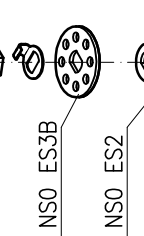
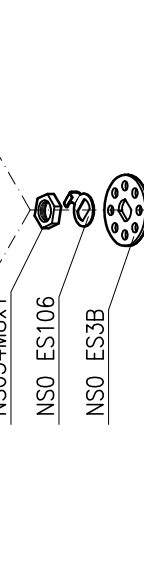
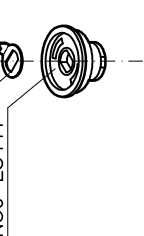
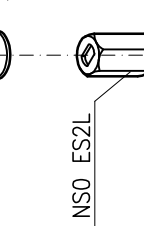
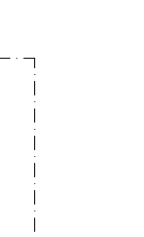
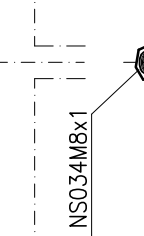
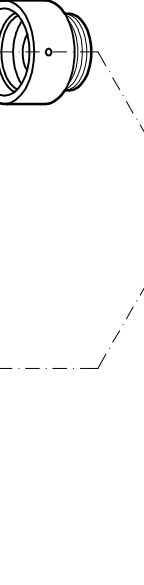
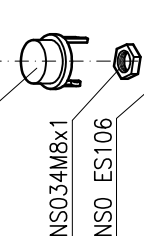
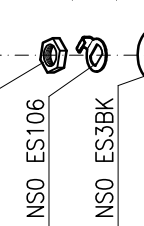
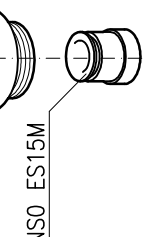
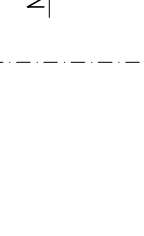
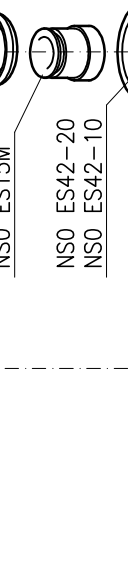
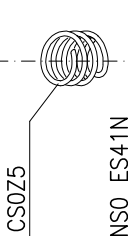
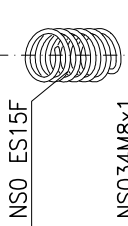
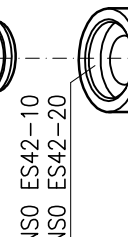
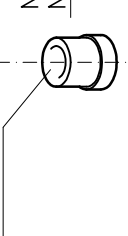
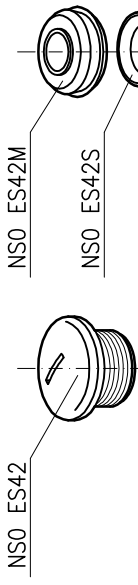
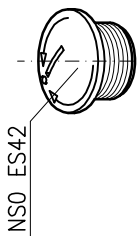
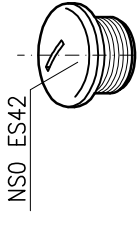
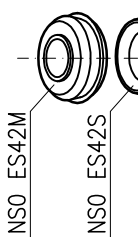
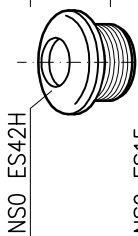
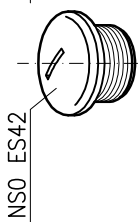

Spohn+Burkhardt
MAUERGASSE 5 • 89143 BLAUBEUREN GERMANY

Fon +49 7344 171-0 info@spobu.de
Fax +49 7344 171-99 www.spobu.de

Spobu Ident.-Nr.	Typ	Bezeichnung	Description	EUR
13327	CS024Z-80	Verriegelungsrohr mit Griffsteller für CS0-V ohne Kreuzkulissee Hebel 110 mm	Locking pipe with operating bush (CS0 without cross gate)	
13326	CS024Z-115	Verriegelungsrohr mit Griffsteller für CS0-V ohne Kreuzkulissee Hebel 140 mm	Locking pipe with operating bush (CS0 without cross gate)	
13323	CS025KZ-62	Verriegelungsrohr mit Griffsteller, für CS0-E und CS0-V mit Kreuzkulissee Hebel 110 mm	Locking pipe with operating bush (CS0 with cross gate)	
13324	CS025KZ-99	Verriegelungsrohr mit Griffsteller, für CS0-E und CS0-V mit Kreuzkulissee Hebel 140 mm	Locking pipe with operating bush (CS0 with cross gate)	
13701	CS0Z5	Druckfeder	spring	
12766	CS0Z6	Druckfeder	spring	
11784	NS0 ES15	Taste	button	
13778	NS0 ES15F	Totmann Druckfeder	deadman spring	
11606	NS0 ES15M	Taste für wasserdichte Ausführung	button	
11164	NS0 ES2	Mitnehmerbuchse	locating bush	
13714	NS0 ES2L	Mitnehmerbuchse	locating bush	
13257	NS0 ES3B	Totmannscheibe	deadman washer	
13717	NS0 ES3BK	Totmannscheibe	deadman washer	
13235	NS0 ES41	Schaltgriff	knop base	
11732	NS0 ES41D	Schaltgriff	knob base	
13956	NS0 ES41N	Nockenkappe	operating cap	
13957	NS0 ES41T	Führungsteller	operating bush	
12031	NS0 ES41WZ	Schaltgriff	knob base	
12765	NS0 ES42	Kappe	cap	
13281	NS0 ES42-10	Griffoberteil für vorstehende H-Taste	knob base waterproof	
13282	NS0 ES42-20	Griffoberteil für versenkte H-Taste	knob base waterproof	
14853	NS0 ES42H	Kappe	cap	
11776	NS0 ES42M	Gummimembran	seal	
11747	NS0 ES42S	Spannring	ring	
12767	NS034M8x1	Mutter	hexagon nut	
13743	NS0 ES90	Griffoberteil kpl. ohne Taste	entire knob without button	
13748	NS0 ES90H	Griffoberteil kpl. H-Taste	entire knob with H-push button	
13292	NS0 ES90 HD	Griffoberteil kpl. HD-Taste	entire knob with HD-button	
13744	NS0 ES90HDV	Griffoberteil kpl. HDV-Taste	entire knob with HDV-button	
13745	CS0 ES90T	Griffoberteil kpl. Totmann-Taste	entire knob with deadman	
13747	NS0 ES90DR	Griffoberteil kpl. DR-Taste ohne Führungsrohr	entire knob with DR-button, without guide sleeve	
16904	NS0 ES106	Scheibe	washer	

